

Small Signal Schottky Barrier Diodes

Features

- Integrated protection ring against static discharge
- Low capacitance
- Low leakage current
- Low forward voltage drop
- Very low switching time

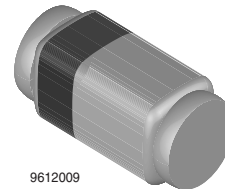

Applications

General purpose and switching Schottky barrier diode

HF-Detector

Protection circuit

Diode for low currents with a low supply voltage

Small battery charger

Power supplies

DC / DC converter for notebooks

Mechanical Data

Case:QuadroMELF Glass Case (SOD-80)

Weight: approx. 33.7 mg

Cathode Band Color: Black

Packaging Codes/Options:

GS18 / 10 k per 13" reel (8 mm tape), 10 k/box

GS08 / 2.5 k per 7" reel (8 mm tape), 12.5 k/box

Parts Table

Part	Type differentiation	Ordering code	Remarks
BAS281	$V_R = 40\text{ V}$	BAS281-GS18 or BAS281-GS08	Tape and Reel
BAS282	$V_R = 50\text{ V}$	BAS282-GS18 or BAS282-GS08	Tape and Reel
BAS283	$V_R = 60\text{ V}$	BAS283-GS18 or BAS283-GS08	Tape and Reel

Absolute Maximum Ratings

$T_{amb} = 25\text{ }^\circ\text{C}$, unless otherwise specified

Parameter	Test condition	Part	Symbol	Value	Unit
Reverse voltage		BAS281	V_R	40	V
		BAS282	V_R	50	V
		BAS283	V_R	60	V
Peak forward surge current	$t_p = 1\text{ s}$		I_{FSM}	500	mA
Repetitive peak forward current			I_{FRM}	150	mA
Forward current			I_F	30	mA

Thermal Characteristics

$T_{amb} = 25\text{ }^{\circ}\text{C}$, unless otherwise specified

Parameter	Test condition	Symbol	Value	Unit
Junction ambient	on PC board 50 mm x 50 mm x 1.6 mm	R_{thJA}	320	K/W
Junction temperature		T_j	125	$^{\circ}\text{C}$
Storage temperature range		T_{stg}	- 65 to + 150	$^{\circ}\text{C}$

Electrical Characteristics

$T_{amb} = 25\text{ }^{\circ}\text{C}$, unless otherwise specified

Parameter	Test condition	Symbol	Min	Typ.	Max	Unit
Forward voltage	$I_F = 0.1\text{ mA}$	V_F			330	mV
	$I_F = 1\text{ mA}$	V_F			410	mV
	$I_F = 15\text{ mA}$	V_F			1	V
Reverse current	$V_R = V_{Rmax}$	I_R			200	nA
Diode capacitance	$V_R = 1\text{ V}$, $f = 1\text{ MHz}$	C_D			1.6	pF

Typical Characteristics ($T_{amb} = 25\text{ }^{\circ}\text{C}$ unless otherwise specified)

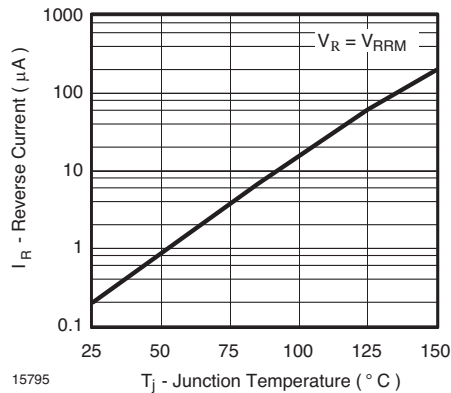
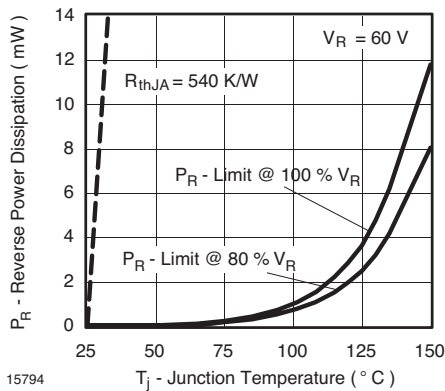

Fig. 1 Max. Reverse Power Dissipation vs. Junction Temperature

Fig. 2 Reverse Current vs. Junction Temperature

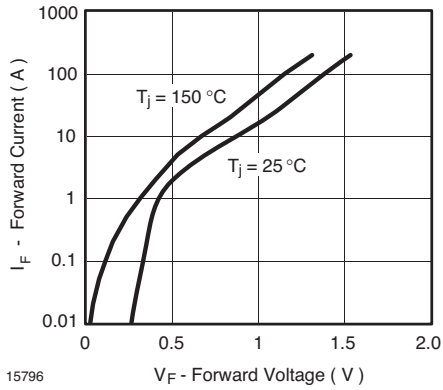

Fig. 3 Forward Current vs. Forward Voltage

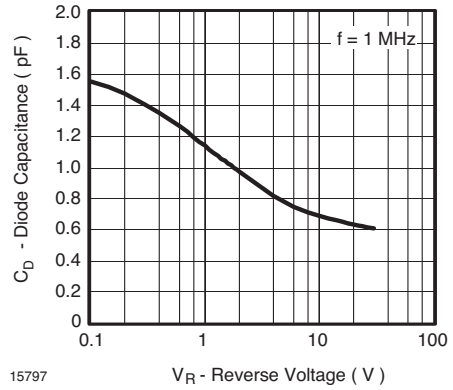
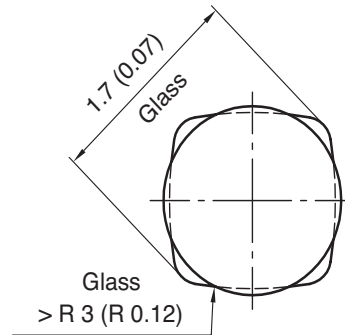
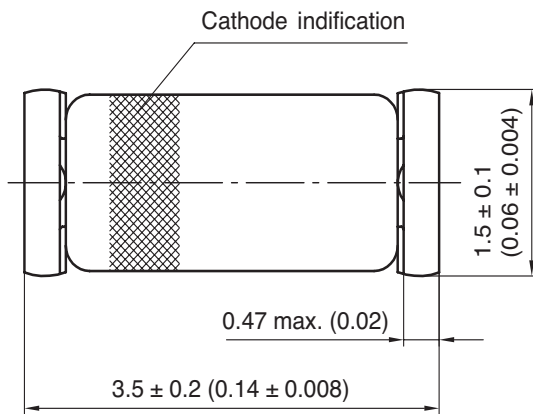
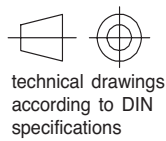
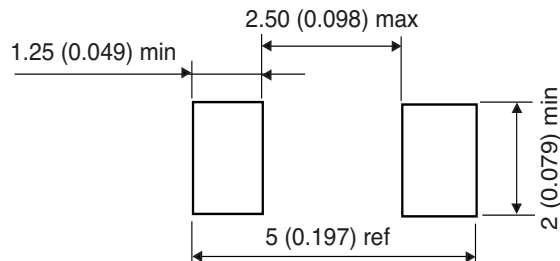

Fig. 4 Diode Capacitance vs. Reverse Voltage

Package Dimensions in mm (Inches)



Mounting Pad Layout



Glass case
Quadro Melf / SOD 80
JEDEC DO 213 AA

96 12071

Ozone Depleting Substances Policy Statement

It is the policy of **Vishay Semiconductor GmbH** to

1. Meet all present and future national and international statutory requirements.
2. Regularly and continuously improve the performance of our products, processes, distribution and operating systems with respect to their impact on the health and safety of our employees and the public, as well as their impact on the environment.

It is particular concern to control or eliminate releases of those substances into the atmosphere which are known as ozone depleting substances (ODSs).

The Montreal Protocol (1987) and its London Amendments (1990) intend to severely restrict the use of ODSs and forbid their use within the next ten years. Various national and international initiatives are pressing for an earlier ban on these substances.

Vishay Semiconductor GmbH has been able to use its policy of continuous improvements to eliminate the use of ODSs listed in the following documents.

1. Annex A, B and list of transitional substances of the Montreal Protocol and the London Amendments respectively
2. Class I and II ozone depleting substances in the Clean Air Act Amendments of 1990 by the Environmental Protection Agency (EPA) in the USA
3. Council Decision 88/540/EEC and 91/690/EEC Annex A, B and C (transitional substances) respectively.

Vishay Semiconductor GmbH can certify that our semiconductors are not manufactured with ozone depleting substances and do not contain such substances.

**We reserve the right to make changes to improve technical design
and may do so without further notice.**

Parameters can vary in different applications. All operating parameters must be validated for each customer application by the customer. Should the buyer use Vishay Semiconductors products for any unintended or unauthorized application, the buyer shall indemnify Vishay Semiconductors against all claims, costs, damages, and expenses, arising out of, directly or indirectly, any claim of personal damage, injury or death associated with such unintended or unauthorized use.

Vishay Semiconductor GmbH, P.O.B. 3535, D-74025 Heilbronn, Germany
Telephone: 49 (0)7131 67 2831, Fax number: 49 (0)7131 67 2423